

WAGATE® KLAFFLUCKOR

TECHNICAL SPECIFICATION

Model no.	KKL 1200X1200
Weight	275 kg
Max On-seating Pressure	5 mH ₂ O
Dimension	1200 mm
vcc	150 mm
hcc	150 mm
Øb	18 mm
#b	20
Max On-seating Pressure	5 mH ₂ O
L2	1370 mm
L3	370 mm
Inner Diameter	1108.20 mm
Outer Diameter	1200 mm
W	1420 mm
H1	1500 mm
L	545 mm

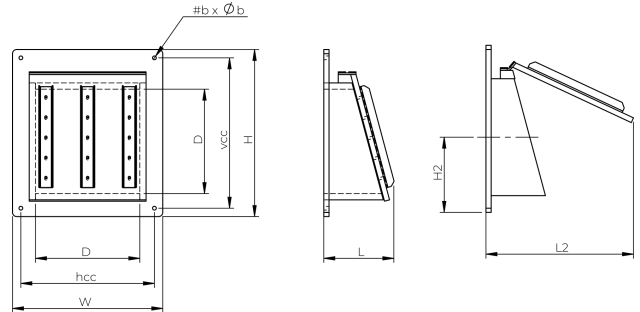

- Tests performed at room temperature (16-20°C).
 - Reference point measured from bottom of pipe."