

# WAGATE® KLAFFLUCKOR

## TECHNICAL SPECIFICATION

<b>Model no.</b>	KKL 710X710
<b>Weight</b>	110 kg
<b>Max On-seating Pressure</b>	5 mH <sub>2</sub> O
<b>Dimension</b>	710 mm
<b>vcc</b>	150 mm
<b>hcc</b>	150 mm
<b>Øb</b>	18 mm
<b>#b</b>	16
<b>Max On-seating Pressure</b>	5 mH <sub>2</sub> O
<b>L2</b>	910 mm
<b>L3</b>	370 mm
<b>Inner Diameter</b>	655.60 mm
<b>Outer Diameter</b>	700 mm
<b>W</b>	930 mm
<b>H1</b>	1010 mm
<b>L</b>	410 mm

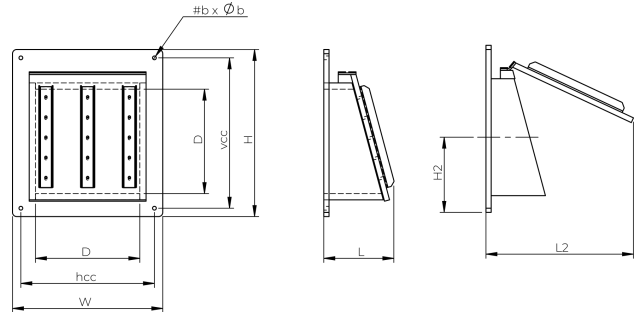

- Tests performed at room temperature (16-20°C).  
 - Reference point measured from bottom of pipe."