

WAGATE® AVSTÄNGNINGSVENTILER

TECHNICAL SPECIFICATION

Model no.	SVM-TG125
Nominal Diameter	DN/OD 125
Available valve body mtrl.	PE
Fasteners mtrl.	AISI 316, Marine grade Stainless Steel
Weight	11 kg
Max On-seating Pressure	40 mH ₂ O
Torque nm	7.00 nm
Thread pitch	4 mm
Dimension	125 mm
Øs	16 mm
Torque nm	7 nm
Thread pitch	4 mm
Max On-seating Pressure	40 mH ₂ O
L1	140 mm
Thickness valve body	162 mm
Inner Diameter	110.20 mm
Outer Diameter	125 mm
W	223 mm
H1	414 mm
L	376 mm
Sealed for one-sided pressure	1

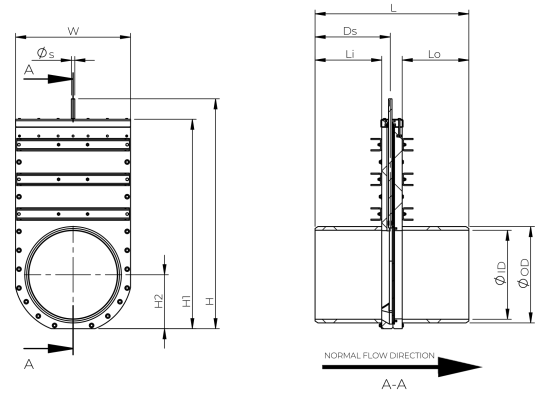

- Tests performed at room temperature (16-20°C).
 - Reference point measured from bottom of pipe."