

WABACK[®] BACKVENTIL

TECHNICAL SPECIFICATION

Model no.	WB160-600
Nominal Diameter	DN/OD 160
Fasteners mtrl.	AISI 316, Marine grade Stainless Steel
Weight	24 kg
Riser	600 mm
Chamber Diameter	600 mm
Invert-Ground min.	650 mm
Construction length	990 mm
Dimension	160 mm
RSK	2359704
Closing Head	100 mmH ₂ O

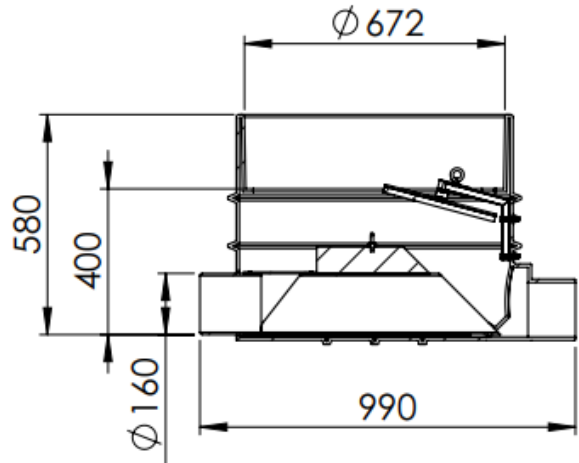

- Tests performed at room temperature (16-20°C).
- Actual values may vary within +/- 15%.
- Reference point measured from bottom of pipe.